

3 CONDUCTIVE POLYMER ALUMINUM ELECTROLYTIC CAPACITORS

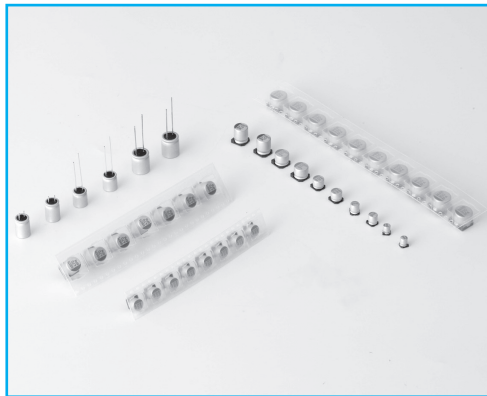

Hi-CAP (Conductive Polymer Aluminum Electrolytic Capacitor)

Hi-CAP is an electrolytic capacitor that uses a highly electric conductive polymer as its electrolyte.

Hi-CAP has excellent temperature and load life characteristics due to adoption of stable polymer in high temperature.

Compared to other electrolytic capacitors, the **Hi-CAP** is a low impedance capacitor suitable for high frequency making it ideal for digital circuit.

1. Circuit design

- (1) The conducting polymer capacitor cannot be used in circuits that undergo frequent charging and discharging because the resulting internal heat buildup can cause capacitor failure.
- (2) Do not use the capacitor in time-constant or coupling circuits. In these type of circuit, electrical characteristics such as capacitance can change under certain environmental conditions.

2. Capacitor handling techniques

(1) Capacitor insertion

Incorrect land size may cause problems with capacitor placement and mountability.

Refer to the land size table for appropriate design dimensions.

(2) Soldering

When using a soldering iron, set the tip temperature to no more than 300°C, and work in as short a time as possible under 10 seconds. While soldering, do not apply strong force to the capacitor.

Reflow soldering

The conducting polymer capacitor is designed specifically for reflow soldering.

Maintain soldering conditions (pre-heating, reflow temperature, time) within the range indicated in the product specifications. If soldering time is lengthened or temperature is higher, the heat can damage the capacitor element and / or the molded case.

Do not perform reflow soldering more than twice.

(3) Circuit board cleaning

Capacitors can withstand immersion in solvent at 60°C or under for up to 5 minutes.

Be sure to sufficiently wash (about 3 min. with water) and dry (20 min. at 100°C) the board afterward.

3. Electrical characteristics comparison of Capacitors

Species	High Frequency	Temperature	Allowable ripple	Miniaturized
Al Electrolytic capacitor	○	○	⊙	●
MLCC	●	○	—	⊙
Film Capacitor	●	●	—	○
Tantal Capacitor	⊙	⊙	○	⊙
Hi-CAP	●	●	●	⊙

※ ● Superior ⊙ Ordinary ○ Inferior

PRECAUTIONS AND GUIDELINES (Conductive Polymer)

The **Hi-CAP** is a Conductive Polymer Solid Aluminum Capacitor that uses highly conductive polymer electrolytic material.

Please read the following in order to get the most out of your **Hi-CAP** capacitor. For aluminum electrolytic capacitors, please refer to PRECAUTIONS AND GUIDELINES

1. Designing Device Circuits

1) Types of Circuits Where Hi-CAP Capacitors are Not to be Used

The leakage current in conductive polymer solid aluminum capacitors(hereafter called Hi-CAP) may vary depending on thermal stresses during soldering. Avoid the use of capacitors in the following types of circuits:

- ① High-impedance circuits that are to sustain voltages.
- ② Coupling circuits
- ③ Time constant circuits

Because the capacitance varies depending on the environment the capacitors are used in, there is a possibility that the capacitor can affect a time constant circuit where sensitivity to variation in capacitance is required.

- ④ Other circuits that are significantly affected by leakage current

2) Circuit Design

Verify the following before designing the circuit:

- ① The electrical characteristics of the capacitor will vary depending on differences in temperature and frequency.
You had better design after verifying the scope of these factors.
- ② When connecting two or more capacitors in parallel, ensure that the design takes current balancing into account.
- ③ When two or more capacitors are connected in series, variability in applied voltage may cause over-voltage conditions. Contact Samwha before using capacitors connected in series.
- ④ Avoid putting heat generating parts either around the capacitor or on the reverse of the circuit board

3) Use in High Reliable and Critical Applications

Consult with Samwha before using these capacitors in applications involving human life: Aviation/space equipment, Nuclear power equipment, Medical equipment and Automotive equipment, or in applications where capacitor failure could have a major impact

4) Polarity

The Hi-CAP is a polarized solid aluminum electrolytic capacitor. Do not apply either reverse voltages or AC voltages to the polarized capacitors, using reversed polarity may cause a short circuit. Refer to the catalog product specifications or capacitor body to confirm the polarity prior to use

5) Operating Voltage

Do not apply a greater than rated voltage, if a voltage greater than the rated voltage is suddenly applied the leakage current increases causing shorting. The peak voltage of superimposed AC voltages(ripple voltages) on DC voltages must not exceed the full rated voltage. While there are specifications for surge voltages exceeding the rated voltage, usage conditions apply, and continued operation for extended periods of time under such conditions cannot be guaranteed.

CONDUCTIVE POLYMER ALUMINUM ELECTROLYTIC CAPACITORS

6) Surge voltage

The maximum instantaneous voltage which may be applied to the terminations of the capacitor for a specified time at any temperature with the operating temperature range.

Rated voltage (VDC)	2.5	4	6.3	10	16	20	25	35
Surge voltage (VDC)	3.3	5.2	8.2	11.5	18.4	23	32	44

7) Ripple current

Do not apply currents in excess of the rated ripple current. The superimposition of a large ripple current increases the rate of heating within the capacitor. When excessive ripple current is imposed the internal temperature increases which can shorten life and shorting may occur.

8) Operating temperature

Use within the stated category temperature range, if used outside this range, characteristics can deteriorate potentially leading to problems.

9) Charging and Discharging in Capacitor

Do not use the Hi-CAP in circuits where the capacitor is repetitively charged and discharged rapidly. Repetitively charging and discharging the capacitor rapidly may reduce the capacitance or may cause damage due to internal heating. Use of a protective circuit to ensure reliability is recommended when rush currents exceed 20A.

10) Leakage current

The leakage current may increase when the capacitors are subjected to the conditions below. After that, however, the leakage current will gradually decrease by self-healing action of the dielectric oxide layer when the capacitors are applied with a voltage less than the rated voltage within the Category Temperature range. As the voltage is closer to the rated voltage and the temperature is closer to the upper limit of Category Temperature range, the leakage current decreases faster.

The leakage current will increase by the following factors,

- ① Soldering
- ② Testing of high temperature exposure with no voltage applied, high temperature/humidity storage, temperature cycles, etc.

11) Failures and Service Life

Based on the KS C 6032 Standard, the failure rate for Hi-CAP(with a 60% reliability standard) is as follows: 0.5%/1,000 hours(applied the rate voltage at the upper limit of Category Temperature range)

(1) Failure Modes

- ① The principal failure mode is wear-out failure, that is, capacitance decreases and ESR increases, and eventually the capacitors become open circuit failure. In addition, short circuit failure may happen with over-voltage and excessive current applied to the capacitors.
- ② The failure rate would be reduced by reducing ambient temperatures, ripple current and applying voltage.
- ③ If the short-circuited capacitor, which may be caused by over-voltages higher than the rated voltage or other conditions, has a large amount of current passed through, the aluminum can of the capacitor bulges and might be expelled with odor gas emitted.
- ④ The product contains flammable materials. If the short causes a spark it may ignite. Please be careful when installing the product, its position and the layout design.
 - ▶ Increase safety by using in conjunction with a protective circuit or protective equipment.
 - ▶ Install measures such as redundant circuits so that the failure of a part of the equipment will not cause unstable operation.

(2) Service Life

Hi-CAP uses rubber as the sealing material, so the service life depends on the thermal integrity of this rubber. Consequently, it is recommended to use the capacitor at a lower temperature than the maximum temperature for the capacitor category.



12) Capacitor Insulation

Insulation of the capacitor's case is not guaranteed. Ensure electrical insulation between the capacitor case, negative electrode, positive electrode and circuit pattern.

13) Capacitor Usage Environment

Do not use/expose capacitors to the following conditions.

- ① Oil, water, salty water, take care to avoid storage in damp locations.
- ② Direct sunlight
- ③ Toxic gases such as hydrogen, sulfide, sulfurous acids, nitrous acids, chlorine and chlorine compounds, bromine and bromine compounds, ammonia, etc.
- ④ Ozone, ultraviolet rays and radiation.

14) Storage

(1) SMD Type

- ① Do not store the Hi-CAP at high temperatures and high humidity. Avoid direct sunlight. (Recommendable conditions 5 to 35°C, 45 to 75% RH)
- ② To keep good solderability, store the Hi-CAP not more than 6 months after delivery and 30 days after unseal.

	Before unseal	After unseal
A period of storage (SMD)	Within 1 year after delivery (Sealed conditions)	Within 30 days of unseal (Packaged condition with carrier tape)

- ③ The Hi-CAP should not be direct contact with water, salt spray, oil spray or high humidity.
- ④ The Hi-CAP must not be exposed to toxic gases such as hydrogen sulfide, sulfurous acid, nitrous acid, chlorine, ammonia, etc.

(2) LEAD Type

- ① Do not store the Hi-CAP at high temperatures and high humidity. Avoid direct sunlight. (Recommendable conditions 5 to 35°C, 45 to 75% RH)
- ② To keep good solderability, store the Hi-CAP not more than 1 year after delivery and 7 days after unseal.

	Before unseal	After unseal
A period of storage (LEAD)	Within 1 year after delivery (Sealed conditions)	Within 7 days of unseal

- ③ The Hi-CAP should not be direct contact with water, salt spray, oil spray or high humidity.
- ④ The Hi-CAP must not be exposed to toxic gases such as hydrogen sulfide, sulfurous acid, nitrous acid, chlorine, ammonia, etc.

SOLID TYPES

PART NUMBER SYSTEM

● Part Number System

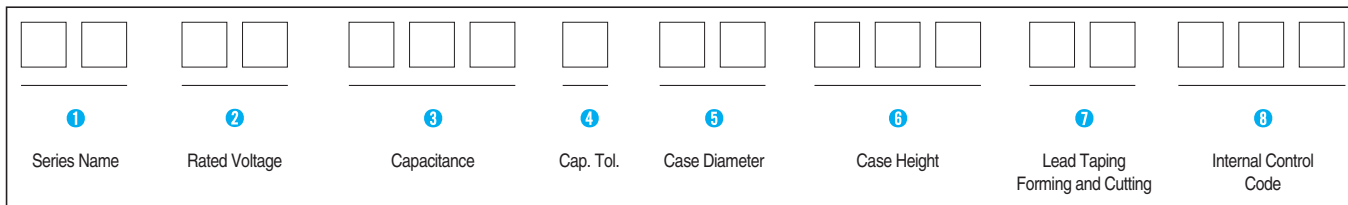

1 Series Name
See page 6

2 Rated Working Voltage

WV	2.5	4	6.3	10	16	20	25
Code	0E	0G	0J	1A	1C	1D	1E

3 Capacitance

- ex) 0.47 μ F 474
- 4.7 μ F 475
- 47 μ F 476
- 470 μ F 477
- 4700 μ F 478
- 47000 μ F 479

4 Capacitance Tolerance

Tolerance (%)	± 10	± 20	-10 $+20$	-10 $+30$	-10 $+50$
Code	K	M	V	Q	T

5 Case Diameter

- ex) $\varnothing 5$ 05
- $\varnothing 6.3$ 6L
- $\varnothing 8$ 08
- $\varnothing 10$ 10

6 Case Height
ex) 5.9mm 059
 6.0mm 006
 10.0mm 010
 11.5mm 115
 11.9mm 119

7 Lead Taping, Forming and Cutting
See pages 59 ~ 60

● Taping Specifications for Lead Type Polymer Capacitors

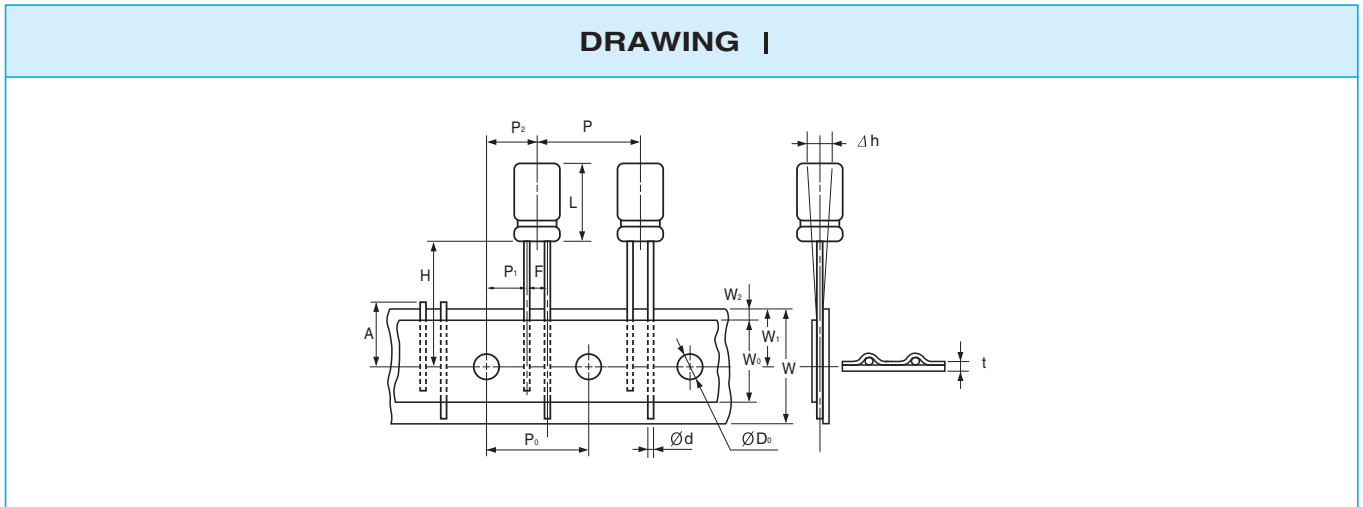

Applicable Drawing No.			I			
Description	Symbol	Tolerance	Ø6.3	Ø8		Ø10
Body Height	L	+1	6, 8	9	12	13
Lead Dia.	Ød	±0.05	0.45	0.60	0.60	0.6
Body Pitch	P	±1.0	12.7			
Feeding Hole Pitch	P ₀	±0.2	12.7			
Feeding Hole Alignment	P ₁	±0.7	5.1			3.85
Feeding Hole Alignment	P ₂	±1.0	6.35			
Lead Center Spacing	F	+0.6/-0.2	2.5	3.5		5.0
Body Inclination	Δh	±2.0	0			
Tape Width	W	±0.5	18.0			
Adhesive Tape Width	W ₀	min.	9.5	12.5		
Feeding Hole Alignment	W ₁	±0.5	9.0			
Adhesive Tape Margin	W ₂	max.	2.0			
Length from Seating Plane	H	±0.5	17.5	20.0		18.5
Feeding Hole Dia.	ØD ₀	±0.2	4.0			
Total Tape Thickness	t	±0.2	0.7			
Cut Lead Height	A	max.	11.0			
Taping Code	Ammo	⊕ leader	PC	PF		PA

● PACKAGING Q'ty(pcs.) / BOX

Size		Ammo			
ØD	Case Height	L	H	W	Q'ty
6.3	6	332	230	42	1500
	8	332	230	49	1500
8	9	332	230	49	1000
	12	332	230	49	1000
10	13	332	190	51	500

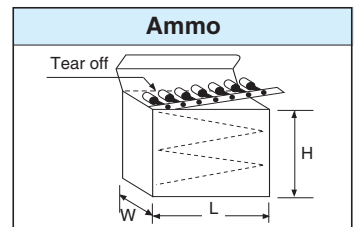

● BULK PACKING QUANTITY(PCS) / BOX

Size		V-BAG	INNER BOX	MIDDLE BOX
D	L			
6.3	6	750	6000	24000
	8	700	5600	22400
8	9	400	2800	11200
	12	400	2800	11200
10	13	250	1500	6000

● CUTTING PACKING QUANTITY(PCS) / BOX

Size		V-BAG	INNER BOX	MIDDLE BOX
D	L			
6.3	6	750	6000	24000
	8	750	6000	24000
8	9	500	4000	16000
	12	400	3200	12800
10	13	250	1500	6000

SOLID TYPES

CONDUCTIVE POLYMER ALUMINUM ELECTROLYTIC CAPACITORS

● Taping Specifications for SMD Type Polymer Capacitors (Vertical type)

● Carrier Tape

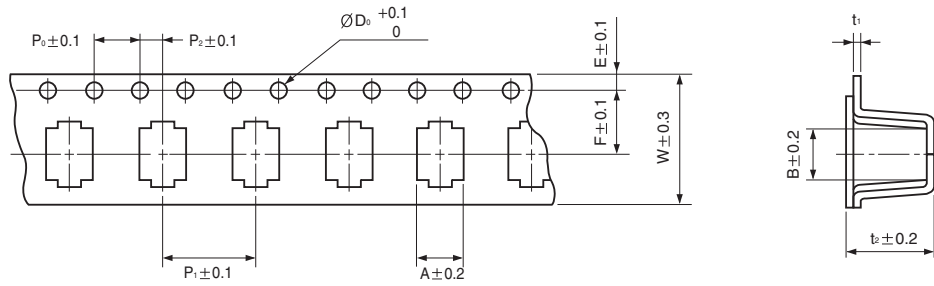

∅D×L	A	B	∅D ₀	E	F	P ₀	P ₁	P ₂	t ₁	t ₂	W
4×5.4	4.7	4.7	1.5	1.75	5.5	4	8	2	0.4	5.7	12
5×5.9	5.7	5.7	1.5	1.75	7.5	4	8	2	0.4	6.3	16
6.3×4.5	6.9	6.9	1.5	1.75	7.5	4	12	2	0.4	4.7	16
6.3×5.9	7.0	7.0	1.5	1.75	7.5	4	12	2	0.4	6.3	16
8×6.9	8.7	8.7	1.5	1.75	11.5	4	12	2	0.4	7.2	24
8×11.9	8.7	8.7	1.5	1.75	11.5	4	16	2	0.4	12.3	24
10×7.9	10.7	10.7	1.5	1.75	11.5	4	16	2	0.4	8.2	24
10×12.6	10.7	10.7	1.5	1.75	11.5	4	16	2	0.5	13	24

● Reel(Taping Code : VR)

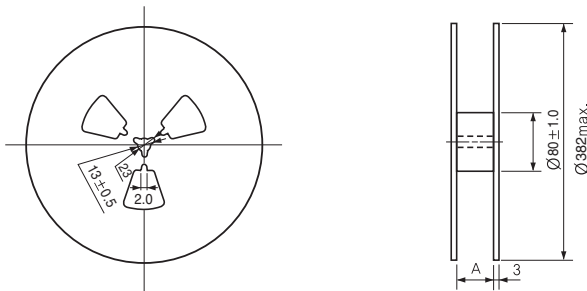

∅D×L	A	∅D×L	Q'ty/Reel(pcs)	Q'ty/Box(pcs)
4×5.4	13	4×5.4	2000	20000
5×5.9	17	5×5.9	1500	15000
6.3×4.5	17	6.3×4.5	1000	10000
6.3×5.9	17	6.3×5.9	1000	10000
8×6.9	25	8×6.9	1000	10000
8×11.9	25	8×11.9	400	4000
10×7.9	25	10×7.9	500	5000
10×12.6	25	10×12.6	400	4000

● Recommended Land Size

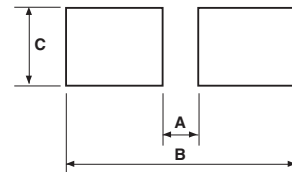

∅D×L	A	B	C
4×5.4	1.0	6.2	1.6
5×5.9	1.4	7.4	1.6
6.3×4.5	2.1	9.1	1.6
6.3×5.9	2.1	9.1	1.6
8×6.9	2.8	11.1	1.9
8×11.9	2.8	11.1	1.9
10×7.9	4.3	13.1	1.9
10×12.6	4.3	13.1	1.9

● Recommendable reflow soldering temperature

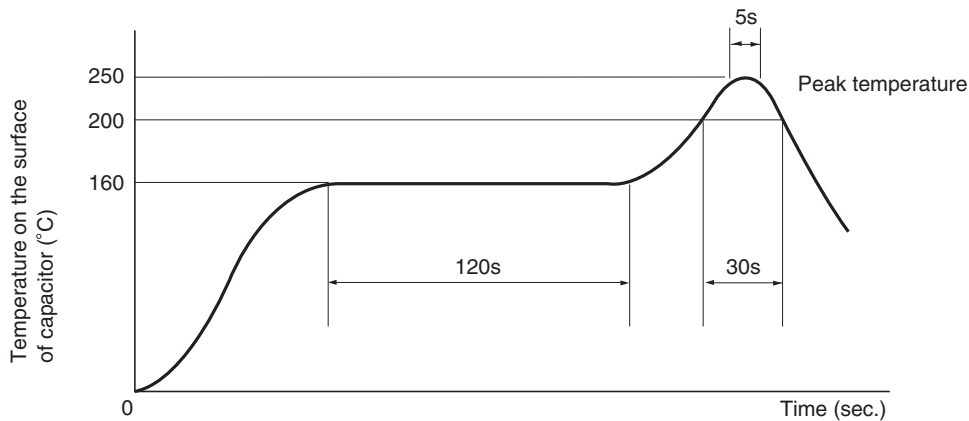

FA Chip type, With Conductive Polymer Series

Hi-CAP



- Low ESR, high ripple current
- Designed for surface mounting on high density PC board
- Load life for 2000 hours at 105°C
- Complied to the RoHS directive

Item	Characteristics	
Operating temperature range	-55 ~ +105°C	
Leakage current max.*	Less than or equal to the value of Table1	
Capacitance tolerance	±20% at 120Hz, 20°C	
Dissipation factor max.	Less than or equal to the value of Table1	
ESR	Less than or equal to the value of Table1	
Temperature characteristics (Impedance ratio at 100kHz)	Z-55°C / Z+20°C	Z+105°C / Z+20°C
	0.75 ~ 1.25	0.75 ~ 1.25
Load life (after application of the rated voltage for 2000 hours at 105°C, In case of 25WV is applied 20V)	Leakage current	Less than specified value
	Capacitance change	Within ±20% of initial value
	tanδ	Less than 150% of specified value
Resistance to soldering heat (Refer to Page 37 for soldering recommendation)	Leakage current	Less than specified value
	Capacitance change	Within ±10% of initial value
	tanδ	Less than 130% of specified value

* In case of some problems for measured values, measure after applying rated voltage for 2.5 to 20V products or 20V derating voltage for 25V products for 120 minutes at 105°C.

DRAWING

Unit : mm

< Dimensions >

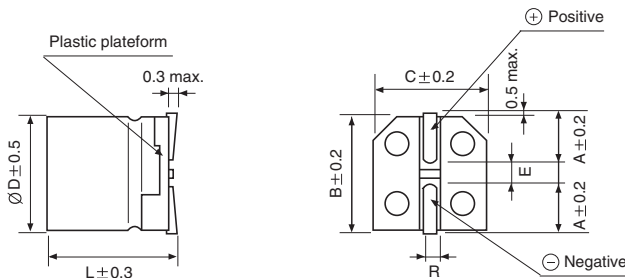

Size	ØD	L	B	C	E	A	R
4×5.4	4	5.4	4.3	4.3	1.0	1.9	0.5~0.8
5×5.9	5	5.9	5.3	5.3	1.4	2.2	0.5~0.8
6.3×5.9	6.3	5.9	6.6	6.6	2.2	2.45	0.5~0.8
8×6.9	8	6.9	8.3	8.3	3.2	2.9	0.5~0.8
8×11.9	8	11.9	8.3	8.3	3.2	2.9	0.8~1.1
10×7.9	10	7.9	10.3	10.3	4.6	3.2	0.8~1.1
10×12.6	10	12.6	10.3	10.3	4.6	3.2	0.8~1.1

< Marking >

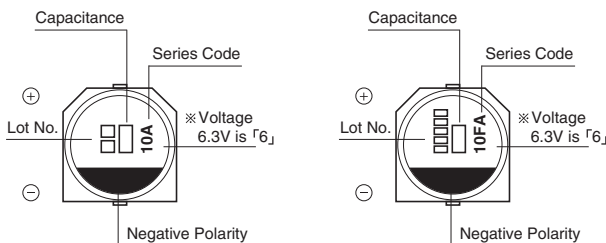

(Ø4, Ø5)

(Ø6.3, Ø8, Ø10)

Series Code "A"

CONDUCTIVE POLYMER ALUMINUM ELECTROLYTIC CAPACITORS

FA Series

● Table 1. FA(SMD type) Series Characteristics List

WV	μF	ØD(mm)	L(mm)	ESR(mΩ)max. 100~300kHz	Ripple current (mA rms)at 105°C 100kHz	Dissipation factor 120Hz	Leakage Current (μA)(max.) after 2 minutes
2.5	180	5	5.9	19	2800	0.10	300
2.5	390	6.3	5.9	15	3160	0.10	300
2.5	560	6.3	5.9	16	3500	0.10	300
2.5	680	8	6.9	20	3370	0.10	500
2.5	820	8	11.9	9	5380	0.10	500
2.5	1000	8	11.9	10	5380	0.10	500
2.5	1200	8	11.9	10	5150	0.10	750
2.5	2700	10	12.6	12	5070	0.10	1350
4	150	5	5.9	20	2730	0.10	300
4	330	6.3	5.9	15	3160	0.10	300
4	560	8	6.9	22	3220	0.10	500
4	560	8	11.9	9	5380	0.10	500
4	1200	8	11.9	12	4700	0.10	960
4	1500	8	11.9	12	4700	0.10	1200
6.3	100	5	5.9	25	2150	0.10	300
6.3	120	5	5.9	21	2660	0.10	300
6.3	220	6.3	5.9	15	3160	0.10	300
6.3	330	6.3	5.9	17	3390	0.10	415
6.3	390	8	6.9	22	3220	0.10	491
6.3	820	8	11.9	12	4700	0.10	1033
10	68	5	5.9	23	2540	0.10	300
10	120	6.3	5.9	22	2600	0.10	300
10	150	6.3	5.9	22	2600	0.10	300
10	270	8	6.9	22	3220	0.10	500
16	39	5	5.9	27	2350	0.10	300
16	68	6.3	5.9	25	2440	0.10	300
16	82	6.3	5.9	25	2490	0.10	300
16	100	6.3	5.9	24	2490	0.10	300
16	120	8	6.9	27	2900	0.10	500
16	150	8	6.9	22	3220	0.10	500
16	270	8	11.9	16	4070	0.10	864
16	330	8	11.9	16	4070	0.10	1056

● FREQUENCY COEFFICIENT OF PERMISSIBLE RIPPLE CURRENT

Frequency	120Hz	1kHz	10kHz	100 ~ 500kHz
Coefficient	0.05	0.3	0.7	1

FB Lead type, With Conductive Polymer Series

Hi-CAP

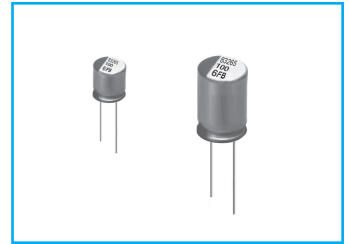

- Low ESR, high ripple current
- Load life for 2000 hours at 105°C
- Complied to the RoHS directive

Item	Characteristics	
Operating temperature range	-55 ~ +105°C	
Leakage current max.*	Less than or equal to the value of Table1	
Capacitance tolerance	±20% at 120Hz, 20°C	
Dissipation factor max.	Less than or equal to the value of Table1	
ESR	Less than or equal to the value of Table1	
Temperature characteristics (Impedance ratio at 100kHz)	Z-55°C / Z+20°C	Z+105°C / Z+20°C
	0.75 ~ 1.25	0.75 ~ 1.25
Load life (after application of the rated voltage for 2000 hours at 105°C, In case of 25WV is applied 20V)	Leakage current	Less than specified value
	Capacitance change	Within ±20% of initial value
	tanδ	Less than 150% of specified value

* In case of some problems for measured values, measure the after applying rated voltage for 2.5 to 20V products or 20V derating voltage for 25V products for 120 minutes at 105°C.

DRAWING

Unit : mm

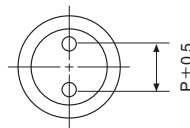
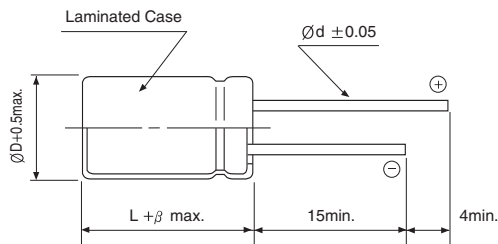

Size	ØD	L	P	Ød	β
5×9	5	9.0	2.0	0.45	1.5
6.3×6	6.3	6.0	2.5	0.45	1.5
6.3×8	6.3	8.0	2.5	0.45	1.5
8×7	8.0	7.0	3.5	0.45	1.5
8×9	8.0	9.0	3.5	0.60	1.5
8×12	8.0	12.0	3.5	0.60	1.5
10×13	10.0	13.0	5.0	0.60	1.5

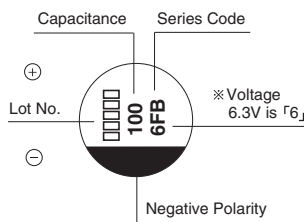

CONDUCTIVE POLYMER ALUMINUM ELECTROLYTIC CAPACITORS

FB Series

● Table 1. FB(Lead type) Series Characteristics List

WV	μF	∅D(mm)	L(mm)	ESR(mΩ)max. 100~300kHz	Ripple current (mA rms)at 105°C 100kHz	Tangent of loss angle(max.)	Leakage Current (μA)(max.)
2.5	220	5	9	7	4180	0.10	500
2.5	330	5	9	7	4180	0.10	500
2.5	330	6.3	9	7	5600	0.10	500
2.5	470	5	9	7	4180	0.10	500
2.5	560	5	5.9	7	4180	0.10	500
2.5	560	6.3	9	7	5600	0.10	500
2.5	560	8	9	7	6100	0.10	500
2.5	820	6.3	9	7	5600	0.10	500
2.5	820	8	7	8	5300	0.10	500
2.5	820	8	9	7	6100	0.10	500
2.5	820	8	12	7	6100	0.10	500
2.5	1000	8	9	7	6100	0.10	500
2.5	1500	8	9	7	6100	0.10	750
2.5	2700	10	13	10	5560	0.10	1350
2.5	3500	10	13	10	5560	0.10	1750
4	560	6.3	9	7	5600	0.10	500
4	560	8	9	7	6100	0.10	500
4	560	8	12	7	6100	0.10	500
4	680	8	12	7	6100	0.10	544
4	820	10	13	7	6640	0.10	656
4	1000	8	9	7	6100	0.10	800
4	1000	10	13	7	6640	0.10	800
4	1200	8	9	7	6100	0.10	960
6.3	220	6.3	6	18	2980	0.10	277
6.3	470	6.3	9	7	5600	0.10	592
6.3	470	8	9	7	5700	0.10	592
6.3	470	8	12	7	5700	0.10	592
6.3	560	6.3	9	7	5600	0.10	705
6.3	560	8	9	7	5700	0.10	705
6.3	680	10	13	7	6640	0.10	857
6.3	820	8	9	7	5700	0.10	1033
6.3	820	8	12	7	5700	0.10	1033
6.3	1500	10	13	10	5560	0.10	1890
10	100	6.3	6	26	2400	0.10	300
10	270	8	7	22	3220	0.10	500
16	100	6.3	6	24	2490	0.10	320
16	100	6.3	9	10	4680	0.10	500
16	150	8	7	22	3220	0.10	500
16	180	8	9	10	5000	0.10	576
16	180	8	12	16	4360	0.10	576
16	220	8	7	13	4150	0.10	500
16	270	8	9	10	5000	0.10	864
16	270	8	12	11	5000	0.10	864
16	330	8	9	11	4520	0.10	1056
16	330	8	12	11	5000	0.10	1056
16	470	10	13	10	6100	0.10	1504

● FREQUENCY COEFFICIENT OF PERMISSIBLE RIPPLE CURRENT

Frequency	120Hz	1kHz	10kHz	100 ~ 500kHz
Coefficient	0.05	0.3	0.7	1